

geeni™

START
GUIDE

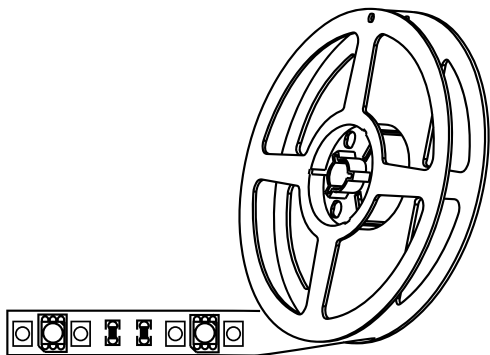

**SMART WI-FI
LED STRIP**

Thank you for purchasing your GEENI smart home product.

Get started using your new devices by downloading Geeni, one convenient app that manages everything straight from your phone or tablet. Easily connect to your home Wi-Fi, and control multiple devices from the touch of your fingertips.

Contents

■ Start Guide	
Download & Register	01
Prepare	02
Connect (Easy Mode)	03
Connect (AP Mode)	04
Questions, Troubleshooting, Notices	06
■ Voice Control Guide	
Google Assistant	08
Amazon Alexa	10
Cortana	12

FCC Notice:

This equipment has been tested and found to comply with the limits for a Class B digital device, pursuant to part 15 of the FCC Rules. These limits are designed to provide reasonable protection against harmful interference in a residential installation. This equipment generates, uses and can radiate radio frequency energy and, if not installed and used in accordance with the instructions, may cause harmful interference to radio communications. However, there is no guarantee that interference will not occur in a particular installation. If this equipment does cause harmful interference to radio or television reception, which can be determined by turning the equipment off and on, the user is encouraged to try to correct the interference by one or more of the following measures:

- Reorient or relocate the receiving antenna.
- Increase the separation between the equipment and receiver.
- Connect the equipment into an outlet on a circuit different from that to which the receiver is connected.
- Consult the dealer or an experienced radio/TV technician for help.

Caution: Any changes or modifications to this device not explicitly approved by manufacturer could void your authority to operate this equipment.

This device complies with part 15 of the FCC Rules. Operation is subject to the following two conditions: (1) This device may not cause harmful interference, and (2) this device must accept any interference received, including interference that may cause undesired operation.

The device has been evaluated to meet general RF exposure requirement. The device can be used in portable exposure condition without restriction.

Important Information:

Before installing or replacing a bulb, read and follow all precautions, including the following: **CAUTION: RISK OF ELECTRIC SHOCK OR BURNS - USE IN A DRY LOCATION ONLY.** The weather resistant IP44 rating only protects the LED strip from splashes in any direction. **DO NOT IMMERSE IN WATER.**

WARNING: The LED strip must be unplugged when making any modifications to the device. Electrical currents are dangerous and may cause electrical shock, injury, or death (in some cases)

Support:

If you encounter any issues, please contact us at support.mygeeni.com for help. To explore our full selection of products, visit us at: www.mygeeni.com
(888) 232-3143 Toll-free

© 2020 Merkury Innovations • 45 Broadway 3rd FL, New York NY 10006. The illustrated product and specifications may differ slightly from those supplied. Geeni is a trademark of Merkury Innovations LLC. iPhone, Apple and the Apple logo are trademarks of Apple Inc., registered in the U.S. and other countries. App Store is a service mark of Apple Inc. Google, Google Play, and related marks and logos are trademarks of Google LLC. iOS is a registered trademark of Cisco in the U.S. and other countries and is used under license. Amazon, Alexa and all related logos are trademarks of Amazon.com, Inc. or its affiliates. All other trademarks and trade names are those of their respective owners.

Made in China

START GUIDE

What's in the Box



- Wi-Fi Controller

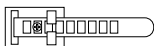

- Anchor Mounts

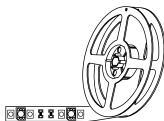

- Smart Wi-Fi LED Strip

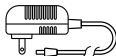

- Power Adapter



- User Manual

Get Ready



- Know your Wi-Fi network and password



2.4GHz

- Make sure you're connecting to a 2.4GHz Wi-Fi network (**Geeni can't connect to 5GHz networks**)



iOS 9



Android 5.0

- Make sure your mobile device is running iOS® 9 or higher or Android™ 5.0 or higher

STEP 1

- Download the Geeni App from App Store or Google Play.



- Register an account on your Geeni App.

01. Enter your mobile phone number or email address

Register

USA +1

Mobile number/E-mail

Continue

02. Enter the verification code and create a password.

Input Verification code

9

Verification code is sent to your phone: 19906728803, Resend (8/5)

03. Log in to the App.

Login

USA +1

Mobile Number / E-mail

Password

Login

STEP 2

■ Plug In

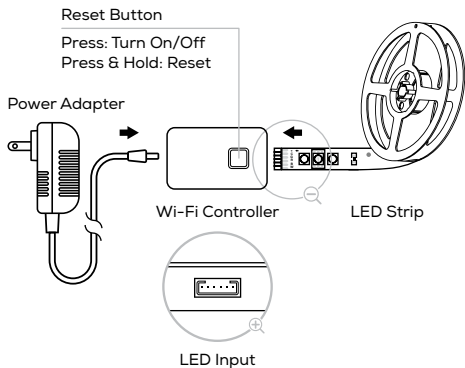

01.

Plug the device into the wall.
Make sure the indicator light on the device is flashing rapidly, indicating the device is ready to connect.

*See reset instructions on p. 5

02.

Measure the area you wish to attach the LED strip to.
Ensure that the area has a clean, solid surface.

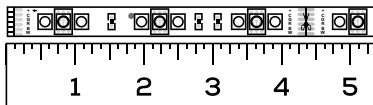

03.

Measure the LED strip for the desired length, starting at the end closest to the connector for the Wi-Fi Controller.

IMPORTANT: If you measure & cut from the opposite end, you will not be able to connect the LED strip to the Wi-Fi Controller.

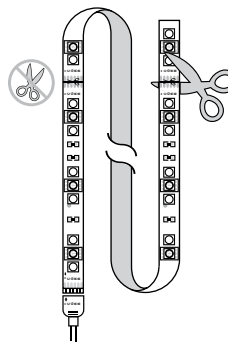

04

Located the closest cut mark to your desired length. Each strip has cut markings located every 10cm.

Take a sharp pair of scissors or blade, and cut along the cut mark.

05

LED Strip Adhesive Installation
*Follow Instructions Carefully

Be sure to thoroughly clean surface or wall with any standard rubbing alcohol before applying adhesive and let dry.



Peel adhesive lining from the back of the strip light.

Position LED strip upon surface and press every section firmly for at least 30 seconds ensuring a strong hold.

NOTE:

3M adhesive may not adhere well to vinyl surfaces nor to delicate wallpaper.

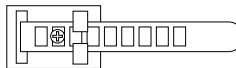

Installation Using Anchor Mounts

If you would like, you may utilize the included anchor mounts for an additional hold. Each mount can be screwed into the wall with a standard Phillips-head screwdriver (not included) or using the 3M adhesive backing.

The LED light strip light can be placed along each mount and then locked in place with the strap.

STEP 3

Add device: Easy Mode

01.
In the Geeni app, on the top corner of the Devices screen, click . Choose "Smart Lighting".

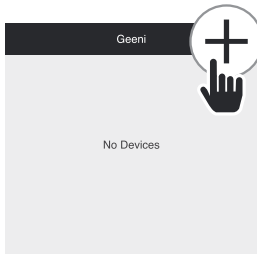

02.
Make sure the indicator light is flashing quickly, indicating it's ready to connect. If not, hold the reset button until it's flashing. Press "Next Step."

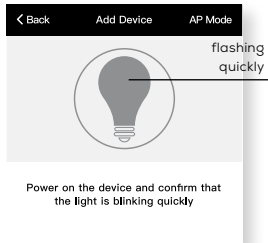

03.
Enter your Wi-Fi network and password.

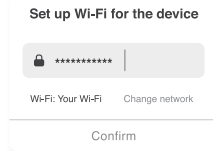

04.
The Geeni app will try to connect your device.

NOTE: Geeni can't connect to 5GHz networks.
"If the connection fails, try to connect using AP Mode."

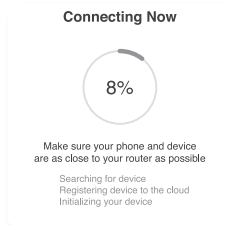

Add device: Backup AP Mode

01.
Make sure the device is in AP Mode, blinking slowly *see reset instructions on p. 5

02.
In the Geeni app, on the top corner of the Devices screen, click . Choose "Smart Lighting". Choose "AP Mode" in the top corner.

03.
Click Next and enter your Wi-Fi details.

04.
Follow the instructions to choose the device from your Wi-Fi list.

05.
The device will connect.
NOTE: Geeni can't connect to 5GHz networks.

"How do I reset the device and what does the blinking light mean?"

Reset the LED strip by pressing & holding reset button.
• Reset once (Press & hold reset button) to reach Easy Mode, which is the primary way the app will try to connect. (When in Easy Mode, you'll see the LEDs flashing quickly, 2x per second)

- Reset again (Press & hold reset button) to reach AP Mode, which is the Backup Mode to help connect. (When in AP Mode, you'll see the LEDs blinking slowly, every 3 seconds)

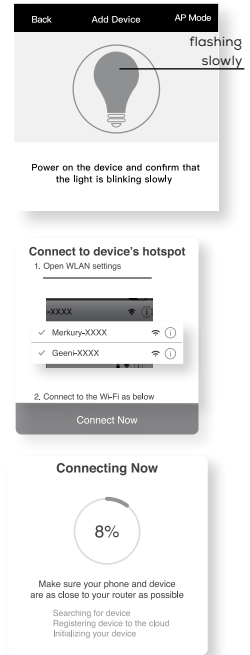

Reset Button | Press: Turn On/Off
Press & Hold: Reset

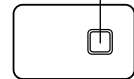

LEDs flashing quickly : Easy Mode
LEDs blinking slowly : AP Mode

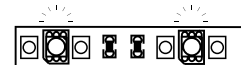

Frequently Asked Questions

■ Can I share with family and friends?

Yes, you can share your bulbs with family and friends who will have access to control your bulbs, plugs, cameras, and other Geeni devices. In the Geeni app, press the Profile button and click on the "Device Sharing" button, and you will be able to give or revoke sharing permissions.

In order to share, the other user should already have downloaded the Geeni app and registered a new account.

■ Can I group multiple Geeni devices together?

Yes, you can group multiple devices of the same type together, by room, location, or however else you want. The same devices can be in multiple groups. (For example, create a group for "Bedroom" and another group for "Entire House", and your Bedroom lights can be included in both groups). From your main device list, click on one of the devices you want to group. Press the "... " button on the top right for advanced settings, and click Create Group. You'll then be able to choose which devices you'd like to group together and will be able to rename them.

■ How Many Devices Can I Control?

Geeni app can control an unlimited amount of devices in an unlimited amount of locations. Your router may have a limit of how many devices can be connected to one router.

■ My Geeni device has a funny name. How do I rename it?

From your main device list, click on one of the devices you want to rename, press the "... " button on the top right for advanced settings, and click Modify Device Name (or Modify Group Name, if applicable). You'll then be able to choose a more familiar name.

■ The device appears offline or unreachable, what should I do?

Make sure your Wi-Fi router is online and in range. Make sure you have the latest Geeni functionality by clicking "Check for firmware update" in your device settings.

■ What's the Wireless Range?

The range of your home Wi-Fi is heavily dependent on your home router and the conditions of the room. Check with your router specifications for exact range data.

■ If my Wi-Fi/Internet goes down, will Geeni still work?

Geeni products need to be connected to Wi-Fi in order to use them remotely.

Troubleshooting

■ Cannot connect to your Wi-Fi network.

Make sure you entered the correct Wi-Fi password during the Wi-Fi setup. Check whether there are any Internet connection problems. If the Wi-Fi signal is too weak, reset your Wi-Fi router and try again.

Reset the device

- Reset once (Press & hold reset button) to reach Easy Mode, which is the primary way the app will try to connect. (When in Easy Mode, you'll see the LED flashing quickly, 2x per second)
- Reset again (Press & hold reset button) to reach AP, which is the Backup Mode to help connect. (When in AP Mode, you'll see the LED blinking slowly, every 3 seconds)

System Requirements

- Mobile device running iOS® 9 or higher or Android™ 5.0 or higher
- Existing Wi-Fi Network

Technical Specifications

- • Size: 0.5in x 196.8in
- • Input: 100-240V, 50/60Hz
- • Life Span: 25000 Hours
- • Weatherproof:
IP44 (Strip), IP20 (Controller)
- • Wi-Fi: IEEE 802.11N, 2.4GHz
(Not compatible with 5GHz Wi-Fi networks)

VOICE CONTROL GUIDE

Thank you for purchasing your GEENI smart home product. Make sure your devices are already set up using the Geeni app, then follow these steps.

Name and Control Each Device by Voice



Contents

■ Voice Control Guide

Google Assistant	08
Amazon Alexa	10
Cortana	12



To control your GEENI smart bulbs, plugs or surge protectors, just say "OK Google," or "Hey Google," and ask. Make sure your devices are already set up using the Geeni app.

Things you can say*:

"Hey Google, turn on all the lights in my bedroom."
"Hey Google, turn off fan."
"Hey Google, set the bedroom light to orange."
"Hey Google, turn off the coffee machine."
"Hey Google, set the living room to 50%."
"Hey Google, dim porch light."



*Some commands require compatible devices.

01

- Open the Google Home app and go to Home Control in the menu.

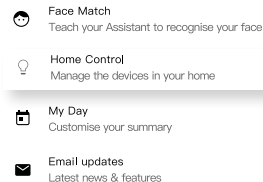

02

- Tap the "+" button.

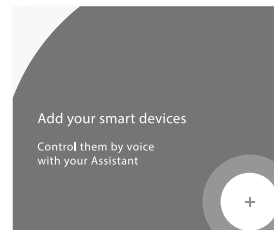

03

- Choose "Geeni" from the list of Home Control partners.

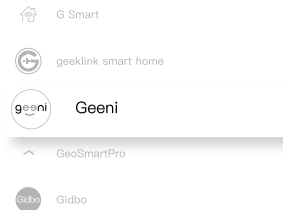

04

- Authorize your account with Google Assistant using the username and password from your Geeni app.

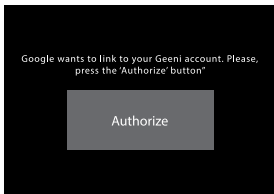

Now your Google Home app and GEENI devices are linked!

You're now able to say "Hey Google" and control your GEENI devices.

- At any time, go into the "Home Control" section of the Google Home app to set nicknames and rooms for your devices. **You can rename your devices in the Geeni app, and Google Assistant will refer to them by the same name.**

So if you rename a smart bulb to "Living Room" or a nickname like "Blossom," then Google Assistant will use that same name later on. You can always give it a nickname using the Google Home app as well. **You can also assign bulbs to a specific room, like "Bedroom" or "Kitchen."**

Google Assistant will be able to control devices by room.



To control your GEENI smart bulbs, plugs or surge protectors, just ask Alexa. Make sure your devices are already set up using the Geeni app.

Things you can say*:

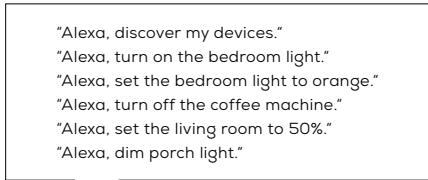

*Some commands require compatible devices.

01

- Open the Alexa app and go to Skills in the menu.

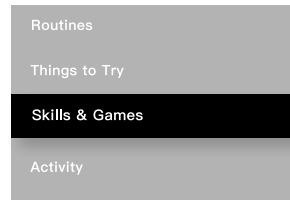

02

- Search for Geeni then tap Enable.

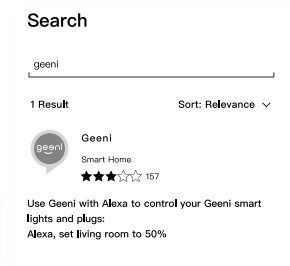

03

- Authorize your account with Smart Home Skills using the username and password from your Geeni app.

04

- Choose "Discover Devices." After a few seconds your GEENI devices will be displayed under Smart Home in the Alexa app.

Discover Devices

Smart Home devices must be discovered before they can be used with Alexa.



- You can rename your devices in the Geeni app, and Alexa will refer to them by the same name.

So if you rename a smart bulb to "Living Room" or a nickname like "Blossom," then Alexa will use that same name later on.

Alternatively, you can create an Alexa group, like "Bedroom" or "Downstairs," and add the device to the group.

Alexa will recognize the group name in the Alexa app, or the device name in the Geeni app.

More information is available at:

<http://tinyurl.com/alexa-smart-home-groups>



Things you can say*:

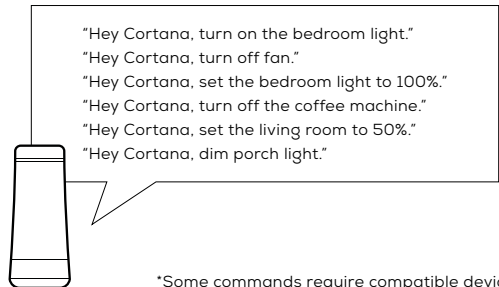

01

- Open the Cortana app and go to Settings in the menu.

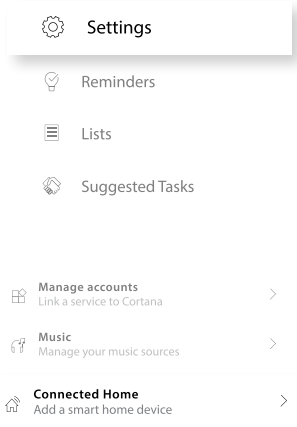

02

- Go to Connections and select the Connected Home option.

To control your GEENI smart bulbs, plugs or surge protectors, just say "Hey Cortana," and ask. Make sure your devices are already set up using the Geeni app.

03

- Choose “Geeni” from the list of Connected Home partners.

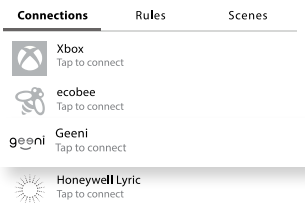

04

- Tap “Connect.”

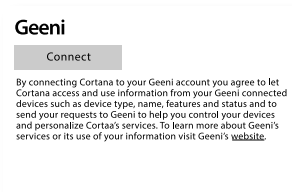

05

- Authorize your account with Cortana using the username and password from your Geeni app.

Now your Cortana app and Geeni devices are linked!

You're now able to say "Hey Cortana" and control your Geeni devices.



Can't connect?
Need help?

**WE
CAN
HELP**

**DO NOT
RETURN THIS
PRODUCT TO
THE STORE**



support.mygeeni.com
(888)232-3143 Toll-free
or tap 'support' for help in the Geeni app.